



ICEU300

Features

- Space-saving 30" (762 mm) wide undercounter design.
- Produces up to 356 lbs (162 kg) of ice per day.
- *Harvest Assist* provides consistent ice production for the life of the ice maker while reducing energy consumption and increasing capacity.
- *Pure Ice®* exclusively by Ice-O-Matic. Built-in antimicrobial protection for the life of the ice maker inhibits bacteria growth on ice maker surfaces. Ice-O-Matic's optional water filtration system provides protection against unpleasant tastes, odors and scale formation.
- Durable, electroless nickel plating on all evaporator plates ensures reliability.
- *Longest warranty in the industry.* Purchase an Ice-O-Matic water filter with your cube ice maker, replace the filter every six months, and the evaporator warranty is extended to 7 years parts and labor (available in the U.S. and Canada only).
- Constructed from corrosion-resistant stainless steel and fingerprint-proof plastic.

Options & Accessories

WATER FILTERS			
Ice Machine Model	Manifold		Inline
	System	Replacement	System
ICEU300	IFQ1	IOMQ (1)	IFI4C / IFI8C
ICEU305			

Ice Maker Warranty

Every Ice-O-Matic ice maker is backed by a warranty that provides both parts and labor coverage.

- Three years **Parts** and **Labor**.
- Five years **Parts** coverage on the evaporator and compressor.
- Seven years **Parts** and **Labor** on the evaporator when you purchase an Ice-O-Matic water filter with your cube ice maker and replace the filter every six months (available in the U.S. and Canada only).

Ice Form



CUBE

FULL CUBE DIMENSIONS	
W x D x H (in.)	7 ⁵ / ₈ x 7 ⁵ / ₈ x 7 ⁵ / ₈
W x D x H (mm)	22 x 22 x 22
HALF CUBE DIMENSIONS	
W x D x H (in.)	3 ⁵ / ₈ x 7 ⁵ / ₈ x 7 ⁵ / ₈
W x D x H (mm)	10 x 22 x 22

Space-Saving Solutions

- Front air discharge design for compact spaces.
- Low profile top saves counter space.
- Stores up to 97 lbs (44 kg) of ice.
- Easy front access to ice.
- Available with an air-cooled or water-cooled condenser.



Air and Water Cooled

- A. Ice maker water in 3/8" FPT.
- B. Bin and ice maker drain, 3/4" FPT.
- C. Electrical cord on 115 Volt unit.
- D. Condenser water in, 3/8" FPT (water cooled units only).
- E. Condenser water out, 1/2" FPT (water cooled units only).

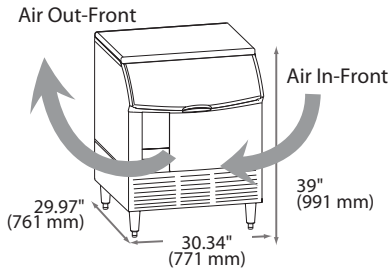
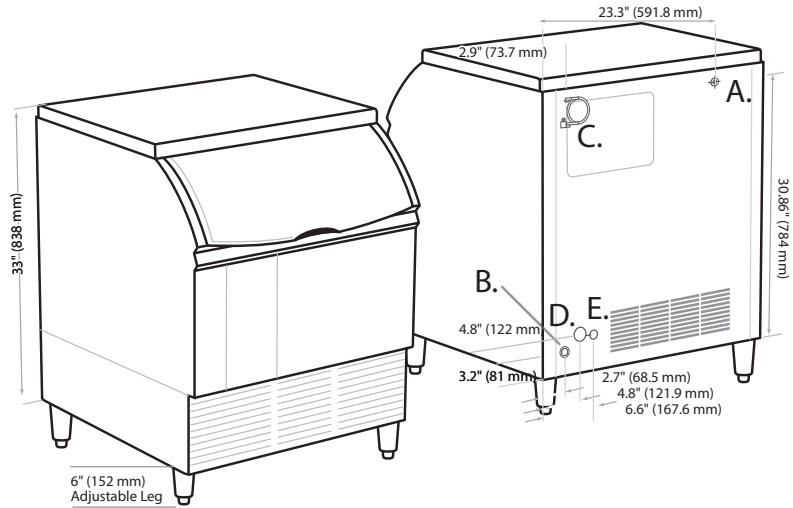

Front & Rear View

ICEU300/305 SELF CONTAINED CUBE ICE MAKER

Operating Requirements

	MINIMUM	MAXIMUM	
		60 Hz	50Hz
Ambient Temp. Range Air	50°F (10°C)	100°F (38°C)	110°F (43°C)
Water Temp.	40°F (4.4°C)		
Water Pressure	20 PSIG (1.4 BAR)	60 PSIG (4.1 BAR)	

Dimensions

ALL MODELS	
W x D x H (in.)	30.34 x 29.97 x 39
W x D x H (mm)	771 x 761 x 991

Specifications

Model Number	Cond. Unit	Ice Production per 24hrs		Water Usage gallons per 100 lbs of Ice 90°F air/70°F water		kWH Used per 100 lbs of ice @ 90°F air/70°F water	Voltage Characteristics	Min. Circuit Ampacity	Fuse Size	Approx. BTUs per hour**
		70°F air/50°F water lbs (kg)	90°F air/70°F water lbs (kg)	Potable	Condenser					
ICEU300A*	Air	309 (140)	228 (103)	32.9	-	8.6	115/60/1	13.1	15	5,928
ICEU300W*	Water	356 (161)	296 (135)	35.6	175	5.7		11.1		6,097
ICEU305A	Air	299 (136)	223 (101)	30.8	-	7.7	220-240/50/1	6.6	16	5,392
ICEU305W	Water	314 (143)	267 (121)	33.9	145	5.4		8.3		5,353

**BTUH is calculated 0°F Evaporator, 100°F Condensing, and 33 PSIG.

NOTES:

- Number of Wires: 3 (including ground)
- Approx. Shipping Weight lbs (kg): ICEU300A 206 (94) • ICEU300W 203 (92) • ICEU305A 206 (93) • ICEU305W 203 (92)
- Refrigerant Type: R404A
- *Cordset included