

S T E A M

VULCAN**KE SERIES
ELECTRIC COUNTER TILTING KETTLE**

Model K12ETT

**SPECIFICATIONS**

(6) (12) gallon capacity, $\frac{2}{3}$ jacketed self-contained electric counter tilting kettle, Vulcan-Hart Model No. (K6ETT) (K12ETT). Ellipsoidal bottom kettle liner formed and fully welded type 316 and type 304 stainless steel exterior with $\frac{1}{4}$ x $\frac{5}{8}$ inch bar rim with butterfly shaped pouring lip and embossed gallon/liter markings, designed to operate at a maximum of 50 psi (3.4 kg/cm²). Jacket contains water, rust inhibitor and antifreeze mixed to protect to 30° below zero. Removable electric elements are field serviceable. Stainless steel tilt handle can be mounted on either the right or left. Two position tilt lock, upright, 100° for emptying and cleaning. Stainless steel water tight control housing located on the right. Controls include a power switch, indicator light, solid state temperature control, vacuum/pressure gauge, pressure relief valve, low water light and low water shut-off. Mounting base includes lugs for bolting to counter top or floor stand. Shipped for 208/60-50/3 electrical service. Can be field converted to 208/60-50/1 and 240/60-50/3 and 240/60-50/1.

Exterior Dimensions:K6ETT: 21 $\frac{3}{4}$ "w x 15 $\frac{1}{2}$ "d x 30 $\frac{1}{2}$ "h.K12ETT: 25 $\frac{1}{2}$ "w x 19 $\frac{1}{2}$ "d x 33"h.

UL listed. UL Classified for sanitation in accordance with ANSI/NSF Standard #4. Meets ASME code.

- K6ETT** 6 gallons/24 quarts/23 liters capacity
- K12ETT** 12 gallons/48 quarts/45 liters capacity

STANDARD FEATURES

- $\frac{2}{3}$ jacketed self-contained electric counter tilting steam kettle.
- Ellipsoidal bottom kettle liner formed and fully welded type 316 and type 304 stainless steel exterior with $\frac{1}{4}$ x $\frac{5}{8}$ inch bar rim with butterfly shaped pouring lip and embossed gallon/liter markings, designed to operate at a maximum of 50 psi (3.4 kg/cm²).
- Jacket contains water, rust inhibitor and antifreeze mixed to protect to 30° below zero.
- Removable electric elements are field serviceable.
- Stainless steel tilt handle can be mounted on either the right or left. Two position tilt lock, upright, 100° for emptying and cleaning.
- Stainless steel water tight control housing located on the right. Controls include a power switch, indicator light, solid state temperature control, vacuum/pressure gauge, pressure relief valve, low water light and low water shut-off.
- Faucet bracket.
- Mounting base includes lugs for bolting to counter top or floor stand.
- Shipped for 208/60-50/3 electrical service. Can be field converted to 208/60-50/1 and 240/60-50/3 and 240/60-50/1.
- One year limited parts and labor warranty.

OPTIONS

- Correction facility package.
 - a. Security type tamper resistant fasteners with tack welds.
- 480 volt, 60 Hz, 3 phase power supply.
- Second year extended limited parts and labor warranty.

ACCESSORIES (Packaged & Sold Separately)

- One piece lift-off stainless steel cover.
- Tilting kettle strainer.
- Kettle tables (see spec F-31898).
- Kettle stand (see spec F-32474 or F-32603).
- Single perforated stainless steel basket assembly.
- (12") (18" double jointed) single pantry faucet.
- (12") (18" double jointed) double pantry faucet.
- Double pantry washdown hose with 16" add-on faucet with backflow preventer.
- Double pantry washdown hose with backflow preventer.
- Double pantry pot filler and backflow preventer.

VULCAN

a division of ITW Food Equipment Group LLC

P.O. Box 696 ■ Louisville, KY 40201 ■ Toll-free: 1-800-814-2028 ■ Local: 502-778-2791 ■ Quote & Order Fax: 1-800-444-0602



KE SERIES ELECTRIC COUNTER TILTING KETTLE

NOTE:

- Dimensions which locate the connections have a tolerance of + or -3" (+ or -75 mm).
- Installation of backflow preventers, vacuum breakers and other specific code requirements is the responsibility of the owner and installer. It is the responsibility of the owner and installer to comply with local codes.
- Plastic drains are not recommended due to limited temperatures of the plastic.
- This appliance is manufactured for commercial installation only and is not intended for home use.

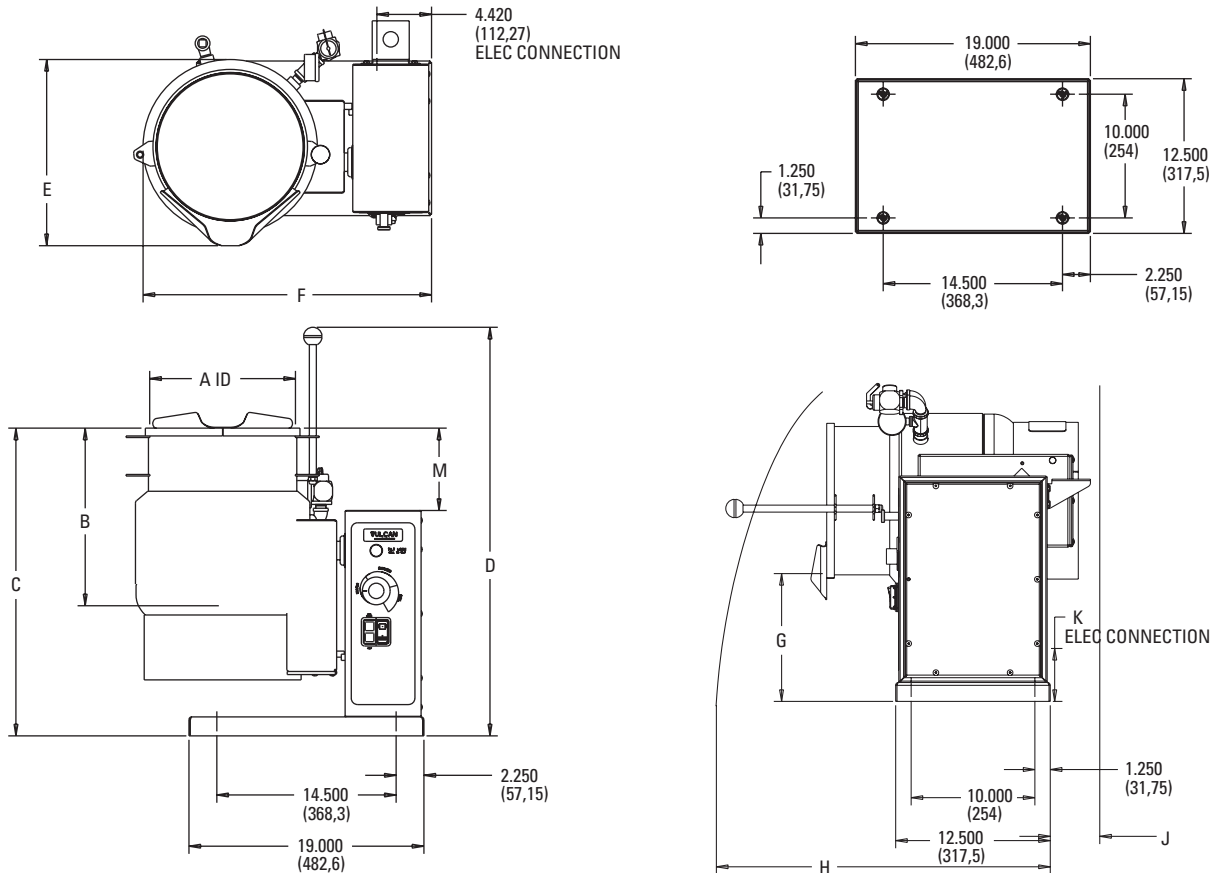

ELECTRICAL CHARACTERISTICS

MODEL	KW	208V		230V		240V		480V
		1 PH	3 PH	1 PH	3 PH	1 PH	3 PH	3 PH
K6ETT	7.5	36	22	N/A	N/A	N/A	N/A	9
	10	N/A	N/A	40	23	42	26	N/A
K12ETT	12	58	33	N/A	N/A	N/A	N/A	14
	16	N/A	N/A	64	37	67	39	N/A

MODEL	CAPACITY		A	B	C	D	E	F	G	H	J	K	M
K6ETT	6 gallons	inches	11.8	14.36	24.88	33.04	15.05	23.33	8.7	27	4	4	6.66
	23 liters	mm	300	365	632	839	382	593	221	686	102	102	169
K12ETT	12 gallons	inches	17.80	13.6	24.37	38.53	20.68	29.34	5.8	27	6	4	6.2
	45 liters	mm	452	345	619	979	525	745	147	686	152	102	156



a division of ITW Food Equipment Group LLC

P.O. Box 696 ■ Louisville, KY 40201 ■ Toll-free: 1-800-814-2028 ■ Local: 502-778-2791 ■ Quote & Order Fax: 1-800-444-0602

NOTE: In line with its policy to continually improve its products, Vulcan reserves the right to change materials and specifications without notice.